

D5 - Evo & D10 Sliding Gate Operator User guide

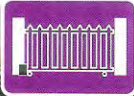

SLIDING GATE OPERATORS



SWING GATE OPERATORS



GARAGE DOOR OPERATORS



REMOTE CONTROLS



INTERCOMS



SAFETY BEAMS



KEYPADS



1. D5-Evo parts identification

Refer to the drawings below, for how to identify your **D5-Evo** operator and its parts.

1. **D5-Evo** controller
2. Courtesy light fuse (3A F/B)
3. Gate mounted origin Marker
4. Origin marker bracket
5. Origin sensor
6. Side covers
7. Foundation plate
8. Motor fuse (30A ATO)
9. 1 x 12V 7.2Ah battery
10. 2A 12V charger
11. Lockable Manual release access door
12. Encoder sensor (clips into support post)

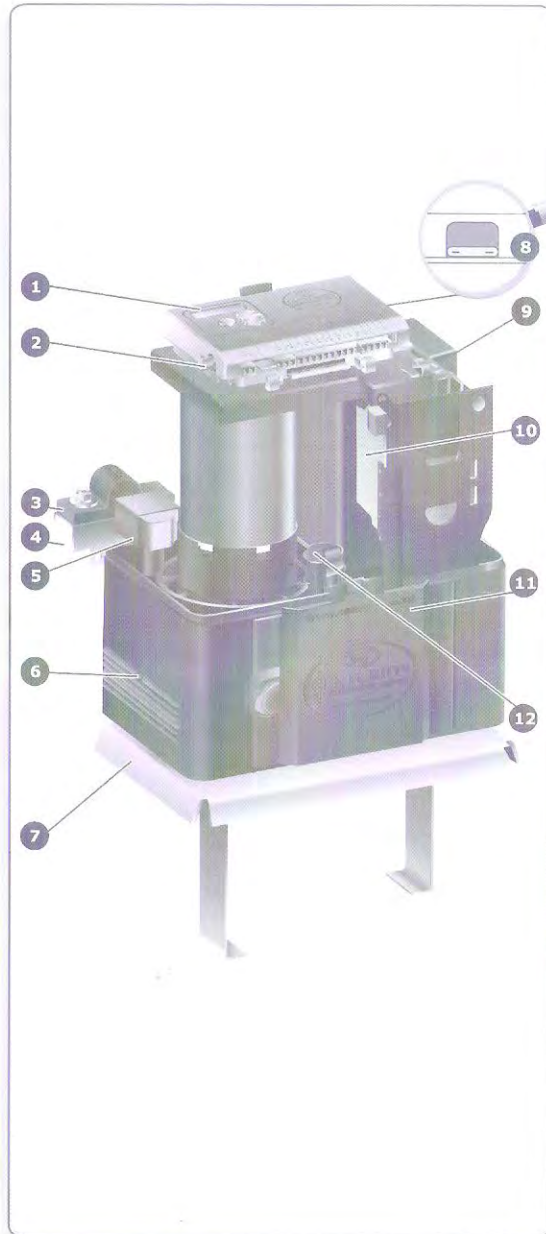

FIGURE 1

2. D10 parts identification

Refer to the drawings below, for how to identify your **D10** operator and its parts.

1. **D10** controller
2. Courtesy light fuse (3A F/B)
3. 2 x 12V 7.2Ah batteries
4. Gate mounted origin marker
5. Origin marker bracket
6. Origin sensor (clip under battery)
7. Lower cover
8. Foundation plate
9. Motor fuse (30A ATO)
10. 2A 24V charger
11. Lockable manual release handle
12. Lock cover
13. Encoder sensor (clip behind charger)

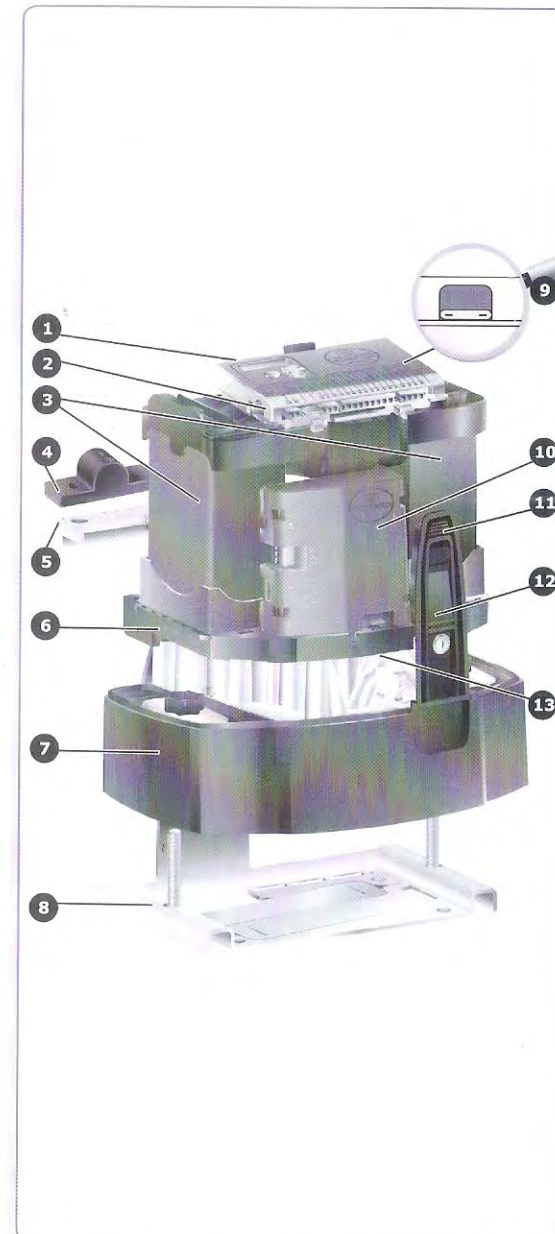

FIGURE 2

3. D5-Evo Manual override

3.1. Disengaging the gearbox/drive

Carefully flip to the side the camlock cover and insert the key and rotate it 90° clockwise.

While holding onto the key, pull open the access door to expose the manual override thumbwheel. This will allow for the removal of the cover, as well as for the rotation of the release thumbwheel.

Rotate the thumbwheel clockwise until gearbox releases and gate can be moved manually.

If the gearbox must be left in manual mode for an extended period of time for whatever reason, it is recommended that the access door is locked. This secures the cover and prevents access to the inside of the unit, which could contain high voltages. It also prevents theft of any components and provides full protection from the elements.

 Do not remove the thumbwheel. Removal of the thumbwheel may result in water entering the gearbox and the warranty will be void.

3.2. Re-engaging gearbox/drive

Rotate thumbwheel anti-clockwise until thumbwheel feels loose in the hand. Make sure that the manual override access door can be closed.

Slide gate until gearbox/drive engages. Never run the motor before the unit is engaged.



FIGURE 3



FIGURE 4

4. D10 Manual override

4.1. Disengaging the gearbox/drive

Flip down the lock cover and insert the camlock key and rotate it 90° clockwise.

Pull down the manual release handle to override the gearbox and allow it to be moved manually.

Reverse the process to re-engage the gearbox/drive.

4.2. Manual release latching

If the gearbox must be left in manual mode for an extended period of time for whatever reason, it is recommended that the manual release is latched, the handle raised back into its normal position and locked, locking the cover in place at the same time. This prevents access to the inside of the unit, which contains high voltages and prevents theft of any components and provides full protection from the elements.

With the manual release handle pulled down, follow the process below to latch the manual release.

- Insert the split pin (supplied with the mounting hardware kit), through the hole in the gearbox as indicated.
- Make sure the split pin goes all the way through as shown
- Raise the handle and lock
- Remove the key and fold back the lock cover.

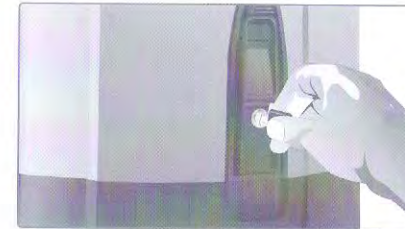

FIGURE 5

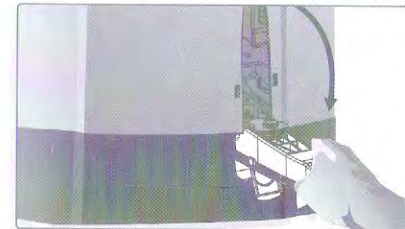

FIGURE 6

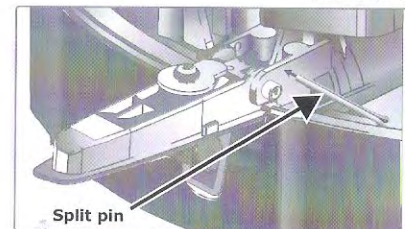

FIGURE 7

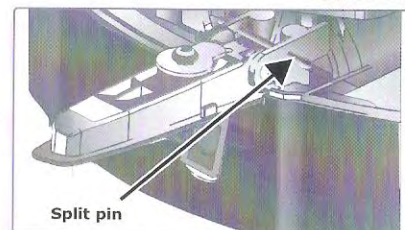

FIGURE 8

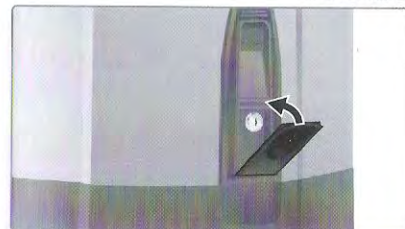

FIGURE 9

5. Features and functions

Introduction

The **D5-Evo** and **D10** sliding gate operators' advanced functions are controlled by intelligent micro-controller based electronic controllers.

An intuitive LCD (Liquid Crystal Display) controller with a user-friendly menu allows for quick and easy set-up and the ability to change functions at the touch of a button and displays useful diagnostics.

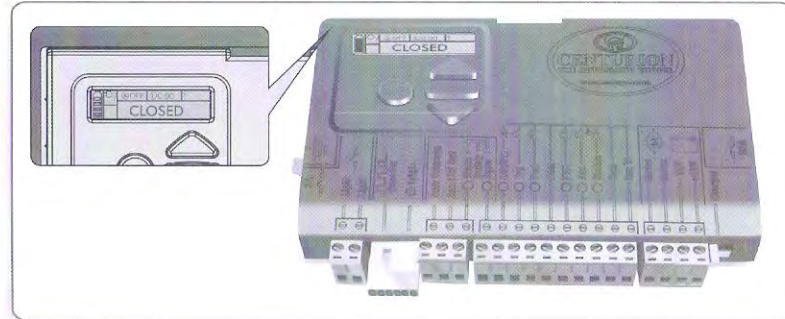

FIGURE 10

5.1. Gate operation

5.1.1. Full Gate Opening

The CENTURION remote controls that operate with the onboard receivers of the **D5-Evo** and **D10** sliding gate operators are used to operate the gate. However, most automatic gate installations are also fitted with an intercom, which provides for communication between the house / building and the gate. The handset is usually fitted with a gate / door release pushbutton, which when pressed, will operate the gate.



FIGURE 11

5.1.2. Modes of Operation

To operate the gate to open fully, the **D5-Evo** and **D10** have a number of operating modes to choose from depending on the application. Only one mode can be selected at any given time.

- **5.1.2.1. Standard Mode**

Standard Mode is the most commonly used mode for domestic applications as it allows full control of the gate. Press the button of the remote control or the gate / door release pushbutton on the

intercom for approximately one second to get the gate in motion. If you press the button again, while the gate is moving, the gate will stop. Press the button for a third time and the gate will go into reverse



Autoclose (page 11) and PIRAC (Beam Autoclose) (page 14) can be used with Standard Mode. An infrared safety beam needs to be installed across the gate entrance and connected to the Closing Safety Beam input on the **D5-Evo** or **D10** to use this function, in order to prevent the gate from closing on people, pets or vehicles. (Page 18)

- **5.1.2.2. Reversing Mode**

Reversing Mode offers slightly more security than Standard Mode as it allows you to close your gate quickly by pressing, for instance, your remote control just as you drive through the gate to prevent children or pets running out - or anybody getting in behind you.

When pressing the button of the remote control or the gate / door release pushbutton on the intercom, your gate will be set in motion. If you press the button again, the gate will move in the opposite direction. So, if the gate is opening and you press the button, the gate will stop and immediately start to close (and vice versa).



Autoclose (page 11) and PIRAC (Beam Autoclose) (page 14) can be used with Reversing Mode. An infrared safety beam needs to be installed across the gate entrance and connected to the Closing Safety Beam input on the **D5-Evo** or **D10** to use this function, in order to prevent the gate from closing on people, pets or vehicles. (Page 18)

- **5.1.2.3. Condominium Mode**

This mode is ideal for increased safety and security in multi-user applications such as townhouses, estates, factories or office parks.

If you select Condominium Mode, your gate will open when pressing the button of the remote control or the gate / door release pushbutton on the intercom - but pressing the button again while gate is opening will be ignored. It will not cause the gate to stop or to reverse. Only the internal Autoclose described on page 11 of this User Guide, which is automatically enabled, will close the gate. If the button of the remote control or intercom gate release is pressed while the gate is closing, the gate will immediately reopen. The gate cannot be stopped in a midway position and will therefore always close. If the button is pressed while the gate is in the open position, the Autoclose timer (Page 11) is reset. Finally, the Autoclose Override feature described on page 11 cannot be applied in this mode.



We highly recommended that you use protection beams if you select Condominium Mode in order to prevent the gate from closing on people, pets or vehicles.



PIRAC (Beam Autoclose) (page 11) can be used with Condominium Mode.

• 5.1.2.4. PLC Mode

This highly specialised mode is suited to industrial applications where a separate computer or programmable logic controller (PLC) is used to operate the gate. Three separate inputs are used to open, stop or close the gate:

- Free-exit input (a trigger from the PLC will only open the gate)
- Holiday Lockout input (a trigger from the PLC will stop the gate)
- Trigger input (a trigger will only close the gate)

Autoclose (page 11) and PIRAC (Beam Autoclose) (page 14) cannot be used with PLC Mode.

• 5.1.2.5. Deadman Control Mode

A variation of PLC Mode, Deadman Control Mode requires a pushbutton to be held in order for the gate to be set in motion. If the button is released, the gate will immediately stop.

Alternatively, an emergency stop pushbutton can be used to permanently hold the gate in "Stop Mode". Releasing the pushbutton will allow your gate to open or close.

If the open or closed triggers are held when the gate reaches the end of its cycle either fully open or fully closed, the internal end-of-travel limit switch system will shut off the motor and prevent further operation in the respective direction.

Autoclose (page 11) and PIRAC (Beam Autoclose) (page 14) cannot be used with Deadman Control Mode.

5.1.3. Automatic closing (Autoclose Mode)

The **D5-Evo** and the **D10** sliding gate operators have the facility to automatically close the gate after it has opened. When enabling this feature, the time that the gate stays open is by default fifteen seconds (this time is adjustable*)

As described in the previous section Autoclose is selectable with Standard and Reversing Modes (page 9) and by default the function is off. However, autoclose is automatically enabled in Condominium Mode.



We highly recommended that a safety beam is installed across the gate entrance and connected to the Closing Safety Beam input on the **D5-Evo** and the **D10**, if you enable Autoclose Mode, in order to prevent the gate from closing on people, pets or vehicles

* It is possible to adjust the delay before the gate closes in one second increments from zero seconds to four minutes. The default time is five seconds.

• 5.1.3.1. Autoclose Override

Automatic closing can be overridden in Standard and Reversing Modes by pressing and holding the button of the remote control or intercom gate release for no less than three seconds. The gate response will be to start opening and then to stop as soon as the Autoclose Override feature is activated. On releasing the button, the gate will continue opening until fully open.

Your gate will stay open until you use the remote control or intercom gate release to close the gate. The **D5-Evo** and the **D10** will then revert to normal Autoclose operation



The Autoclose function cannot be overridden in Condominium Mode.

It is possible to adjust the override time or the time required to hold down the button in order to override autoclose in one second increments from one to ten seconds. The default time is three seconds.

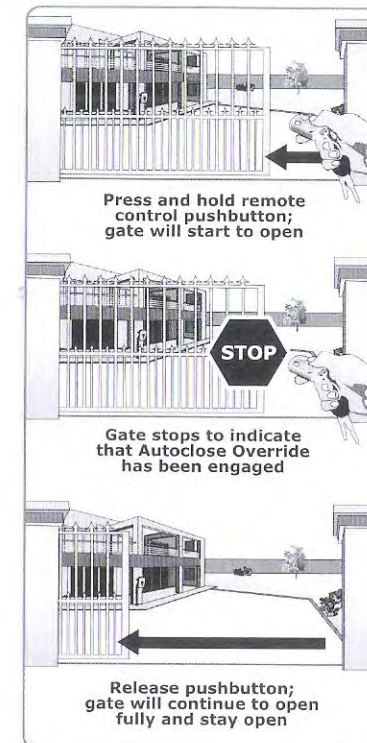

FIGURE 12

5.1.11. Infrared Safety Beam (optional but recommended)

• 5.1.11.1. Closing Safety Beams

Closing Safety Beams provide additional protection against your gate closing on people, pets or vehicles.

If the closing beam is broken while the gate is opening, it will continue to open. If the gate is open, the gate cannot be closed and if the gate is closing, it will stop and reopen.

If you select the Autoclose (page 11) feature, the gate will remain open if the beam is broken and only close after the set Autoclose time has expired when the beam has cleared.

You can use other protection devices like an inductive ground loop instead of an infrared beam, but loops are only sensitive to the presence of a vehicle (large metal objects) and provide no protection to people or other objects in the path of the gate. Please contact CENTURION for more information on suitable protection devices.

• 5.1.11.2. Opening Safety Beams

These beams prevent your gate from opening if an object or person is in the way.

If the beams are broken while the gate is closed, the gate will not open. If the gate is opening, it will stop then close. If the gate is closing, it will continue to close.

Please contact CENTURION for more information on suitable protection devices.

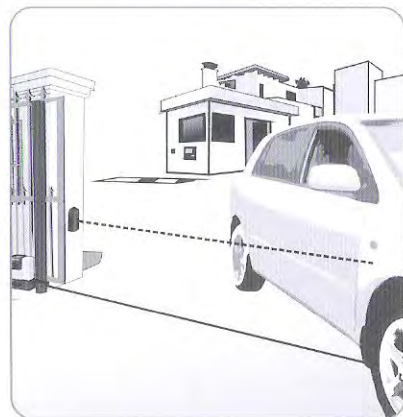

FIGURE 24

Gate open – gate cannot close
Gate closing – gate stops and reopens
Gate opening – gate continues opening

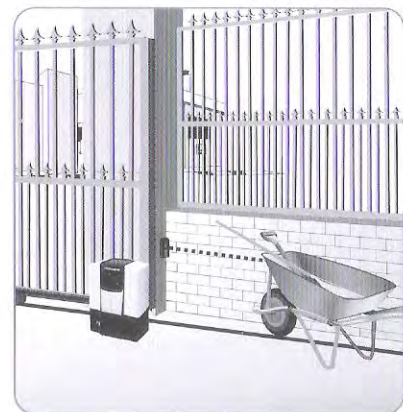

FIGURE 25

Gate closed – gate cannot open
Gate opening – gate stops and re-closes
Gate closing – gate continues closing

5.1.12. Intruder Detection Alarms* (a world first)

• 5.1.12.1. Ambush Alarm

Once activated, if the opening or closing beams are continuously interrupted for a predefined time, the Ambush Alarm will sound. Intruders often cover beams' lenses, thus breaking the beam, so your gate stays open after you have entered or left your property – but with the Ambush Alarm enabled you can be instantly alerted of any criminal activity.

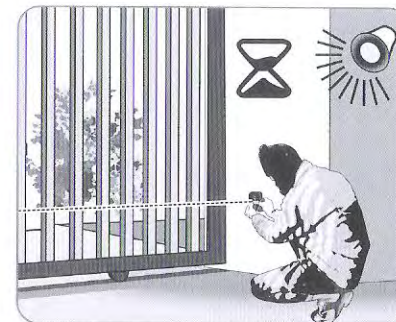

Intruder masks safety beams, 30 seconds later alarm is activated

FIGURE 26

• 5.1.12.2. Break-In Alarm

If the closing beam on the outside of your property is broken, the Break-In Alarm will sound and continue until 30 seconds have passed since the beam is re-made.

Intruders will not be able to loiter outside your property as the Break-In Alarm will immediately alert you of their presence – and the noise of the onboard buzzer is often an effective deterrent. Optionally the alarm signal can be routed to an armed response company.

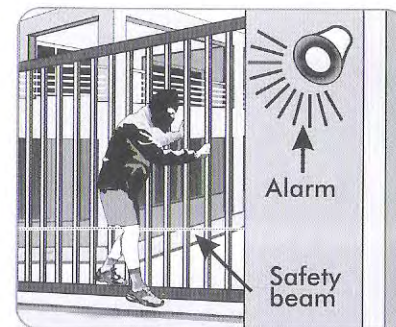

Intruder breaks safety beam while loitering at gate, alarm immediately activated for 30 seconds

FIGURE 27

If the Ambush Alarm or Break-In Alarm is utilised, the system may be configured to operate one of the following outputs provided on the controller:

- Onboard buzzer – emits a continuous tone
- Pillar / Courtesy light contact
- Safety beam common
- Status LED output
- Auxiliary IO (which can be used to connect to a third party alarm and security company, or a CENTURION G-Switch device to alert you of the alarm via SMS)

It is typical to select only one of the alarm features.

* Requires infrared gate safety beams to be installed

5.1.15. Onboard Multichannel Receiver

The **D5-Evo** and **D10** controllers are supplied standard with a multichannel receiver compatible with CENTURION's secure rolling code (Keeloq™ encryption). The receiver will allow any combination of the different inputs (such as Trigger, Pedestrian, Holiday Lockout, etc.) to be operated from a single multi-button remote control.

You can artificially increase the number of buttons of a CENTURION multi-button remote control by using a two button combination. One of the buttons is used as a shift button to allow the other buttons to be used again in combination with this button. Press and hold the shift button and then press one of the other buttons to create a new button. The shift button cannot be used as a button on its own; it must always be used in combination with another button.

Use of the shift key principle allows a three button transmitter to gain an extra button and operate four functions and a four button transmitter gains two extra buttons and can operate six functions.

This is quite handy if you'd like to control additional devices from a single multi-button remote control, for example, your garage doors if they are equipped with CENTURION rolling code receivers.

However it's also important to note that other devices cannot be activated with the new shift button, only the **D5-Evo** and **D10** (and other CENTURION operators that are equipped with an onboard receiver) are able to recognise the shift button signals. Using a shift button also prevents you from enabling functions like Holiday Lockout Mode by accident because you have to use both hands to press the two button combination.

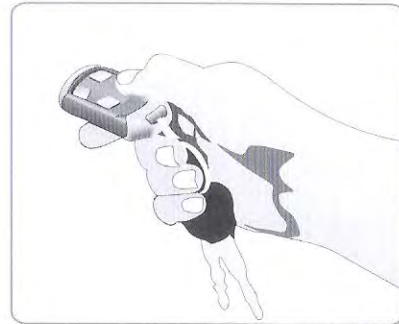

FIGURE 31

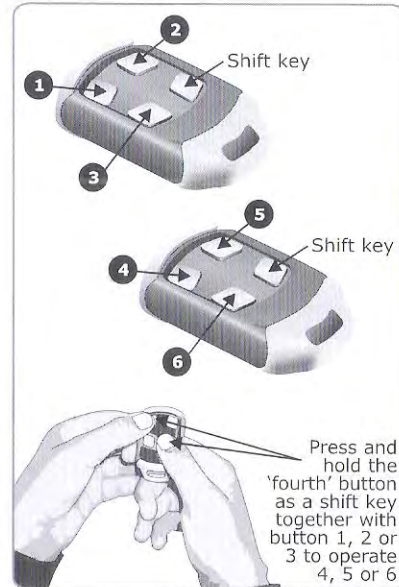

FIGURE 32

Another function provided with this receiver is the ability to record the memory location of each remote control, mapping this to the name of the owner of the remote (if recorded). This allows any transmitter that is lost or stolen to be selectively erased from the system without affecting any of the other remotes installed.

It is also possible to erase the functions of certain buttons on a remote control if they're no longer required. Alternatively, the functionality of certain buttons can be changed to trigger different functions.

At any stage remote controls can be selectively added, deleted or edited within the system.

Contact your gate automation specialist or CENTURION for assistance

5.1.16. ChronoGuard Timer (a world first)

ChronoGuard™ (a world first) is a powerful multichannel timer feature which has been added to the **D5-Evo** and **D10** controllers. A Real Time Clock and Calendar (RTC) lets you set the following features to operate automatically or be prevented from operating (time-barred) during any Time-period you choose:

- Trigger (TRG) (auto activation and time-bar)
- Free-exit (FRX) (auto activation and time-bar)
- Pedestrian opening (PED) (auto activation and time-bar)
- Holiday Lockout (LCK) (auto activation and time-bar)
- Closing Beam (IRBC) (auto activation only)
- Courtesy (Pillar) Light control (AUX) (auto activation and time-bar)
- Courtesy (Pillar) Light relay (time-bar only)
- Auxiliary output (auto activation and time-bar)

- ☼ It is possible to time-bar the operation of the device physically wired to this feature and/or the same feature controlled via the radio receiver.
- ✱ Spare output, which via a relay board can drive a variety of external devices such as sprinkler system, fountain etc.

A Time-period can be a once off event, or can be set to repeat on a weekly or annual basis. The weekly repeat can be chosen to occur on every day of the week, weekdays only, weekends only, or any specific day. The minimum duration of a time-period is one minute – and you can set 100 different Time-periods. The "Tp" icon will appear on the display to indicate that a time-period is active.

You can even set up different conditions by combining Time-periods as well as set up exclusions (once off time periods when the auto activation or time-bar period must be ignored) so your gate will automatically open at certain times on weekdays, but will know not to open on a public holiday.

For your own record and reference purposes if claiming against the warranty - Stick the product Barcode and serial number label for the operator here.

24 month
product
warranty

11. Optional extras

i5 Infrared Safety Beams

Always recommended on any gate automation installation

SmartGUARD keypad

Cost-effective and versatile keypad, allowing for access to pedestrians, armed response companies, etc

SOLO/Lattice Proximity Access Control System

Proximity reader, allowing for access to both pedestrians and vehicles, while offering a higher level of security than a keypad

Pedestrian keyswitch

Allows for pedestrians to partially open the gate using a key

POLOphone Intercom System

Allow visitors to communicate with residents in order to gain access to the property

POLOview Surveillance System

Enhances the POLOphone to provide CCTV at the gate

Theft-resistant Cage

Retro-installable steel cage that increases the resistance of the operator against theft



i5 Infrared safety beams

SmartGUARD keypad



SOLO/Lattice Proximity Access Control System



Pedestrian keyswitch



POLOphone Intercom/Surveillance System



D5-Evo Theft-resistant cage

D10 Theft-resistant cage

FIGURE 38

Optional
extras